

AIRBRUSH PARTS

● GP-Series (GP-35,GP-50,GP-70)

● GP-35/50

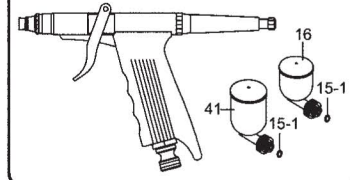

● GP-70

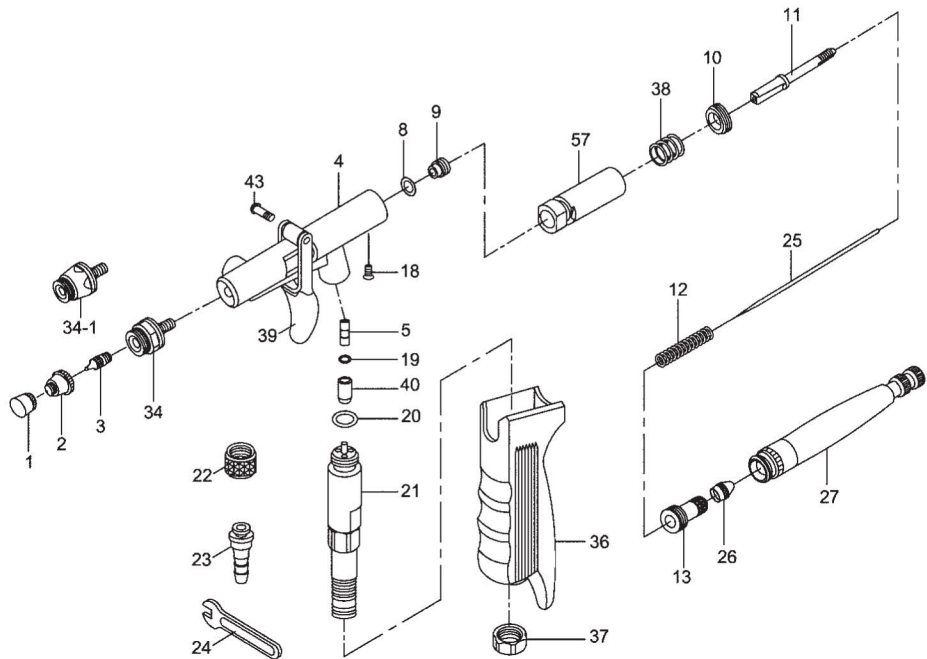
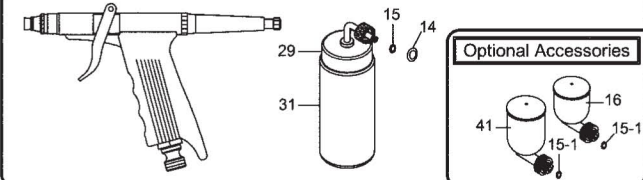

NOTE: See www.SPARMAXair.com for other airbrush models.

INDEX	DESCRIPTION	INDEX	DESCRIPTION	INDEX	DESCRIPTION
1	Needle cap	16	7c.c detachable side cup	34	Nozzle plate (0.5 / 0.7 mm)
2	Nozzle cap	18	Set screw	34-1	Nozzle plate (0.35mm)
3	Nozzle	19	Piston o-ring	36	Grip
4	Body	20	Air valve o-ring	37	Nut
5	Piston	21	Air valve	38	Slider spring
8	O-ring for needle guide	22	Hose connector nut	39	Trigger
9	Needle guide	23	Hose connector	40	Sleeve air valve
10	Lever screw	24	Wrench	41	15c.c detachable side cup
11	Needle chucking guide	25	Needle	43	Set screw
12	Spring	26	Needle chucking nut	57	Slide cam
13	Spring case	27	Handle		
15	O-ring for side cup	29	Connector / bottle cap		
15-1	O-ring for side cup (7c.c / 15c.c)	31	80c.c plastic bottle		

OPERATING INSTRUCTIONS

AIR PRESSURE

The fluidity of the paint will have an effect on what is the ideal pressures to use, so if you are able to vary your working air pressure, the best advice, is to experiment.

PAINT PREPARATION

Whatever kind of paint you use, make sure that it's a milky consistency, you may have to mix some paints with water or a solvent to achieve this. It is best to prepare the paint relatively thin and make repeated passes across the artwork to achieve the desired shade. There are many different types of inks and water colors available that can be used straight from the bottle and are ideal for airbrush work.

OPERATING YOUR AIRBRUSH - pix①

This is a dual action model which allows you to control air and color supply to achieve a vast range of different effects and finishes. For air only, pull back the trigger slightly until a light resistance is felt. Pull back further for paint. The further back the trigger, the greater the amount of paint.

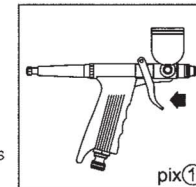

THE START

With dual action airbrushes there is a "golden rule" operation - "AIR ON FIRST, AIR OFF LAST". The key is to start off spraying with air only as mentioned under "OPERATING YOUR AIRBRUSH", then pull the trigger further back for paint. When you stop spraying, make sure the trigger is returned to the "air only" position first before it is fully released. Initially, when you start spraying with your airbrush, you should practice freehand spraying. Hold your airbrush, loaded with paint, about 7.5cm from the surface and just spray away, you'll soon pick up the behavioural patterns of your airbrush. After a while, try varying the spray by moving your airbrush closer to the surface, the finer and stronger the line, the further away, the broader and weaker the line.

A GOOD TIP FOR SPRAYING A CLEAN FINE LINE - pix②

Don't start by pointing the airbrush at the exact spot where you want the line to begin. Start earlier, moving smoothly towards the target point with air only.

When you're in line with the point, pull back the lever for paint.

Similarly, at the end of the line, switch off the paint but carry on for a second or two with air only.

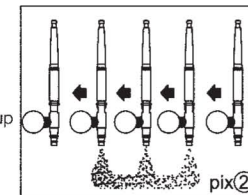

* CLEANING YOUR AIRBRUSH

Keeping your airbrush clean is the simple most important aspect of owning an airbrush.

The vast majority of airbrush problems are connected to the fact that the airbrush is simply blocked up or seized up through lack of regular thorough cleaning.

Your airbrush needs to be cleaned between every color change by flushing through water or a cleaning agent and paint should never be allowed to stand for any length of time in the color cup.

PROCEDURES FOR CLEANING: - pix③

1. Loosen the needle stop screw and pull the bit.
2. Add a few drops of water or cleaning solution.
3. Place your finger or a piece of cloth over the needle cap and blow a little air through to produce backspray into paint passage. This will dislodge any paint residue from the nozzle and the paint passage.
4. Clean the color cup with a Q-tip.
5. Flush out the airbrush with water or cleaner.

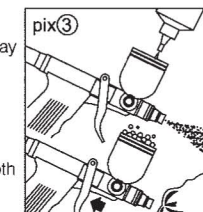

* CLEANING NEEDLES & NEEDLE CAPS

Especially with pigmented colors, paint will build up on the needle and on the inside of the needle cap. Both parts must, therefore, be cleaned frequently.

PROCEDURES FOR CLEANING: - pix④ / pix⑤

1. Loosen the needle chucking nut and pull the needle back a bit.
2. Unscrew the needle cap and clean the inside with a Q-tip and water or Airbrush cleaner.
3. Check the Nozzle from time to time to ensure it is not damaged, only remove it when it needs replacing.
4. Replace needle cap.
5. Carefully insert the needle, pushing it with slight pressure against the nozzle with a little rotating movement to ensure a proper seat. Finally tighten the needle chucking nut.

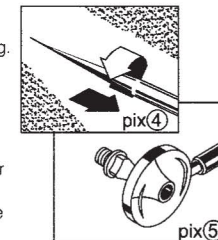

MAINTENANCE & TROUBLESHOOTING

There are three steps you should take as your starting point when carrying out maintenance work on your airbrush.

1. Make sure you have the diagrammatic breakdown and part list of your airbrush at hand, showing all the internal parts. It will enable you to specify a new part should you need one.
2. Choose a work surface that is flat and well lit, it helps to have a magnifying glass at hand for inspecting minute components.
3. Most important of all, if you're not sure what's wrong and don't know how to fix it, consult your dealer, it can be all too easy to make an expensive mistake. Apart from the specific problems where it is indicated you should consult your dealer.

